



Tytan Steel LED

Minimum installation cost
Maximum efficiency





IP65



UGR<19



Tytan Steel LED

A modern industrial luminaire, manufactured in Poland, combining innovative technological solutions and superior lighting parameters with commitment to environmental care

With A-class energy rating, the luminaire is highly energy-efficient, and the low glare rating (UGR<19, UGR<22, UGR<25) ensures comfortable lighting, reducing eye strain.

Its impressive luminous efficiency of up to 192 lm/W makes it one of the most efficient industrial luminaires on the market. The 1.2 m version generates a luminous flux of up to 15,300 lm, which is a very high value for this class of products.

Quick mounting

The Tytan Steel LED luminaire stands out for its extremely fast and easy mounting, which significantly reduces installation time. No specialised tools are required for its installation. This is the perfect solution for businesses which value efficiency and time savings.

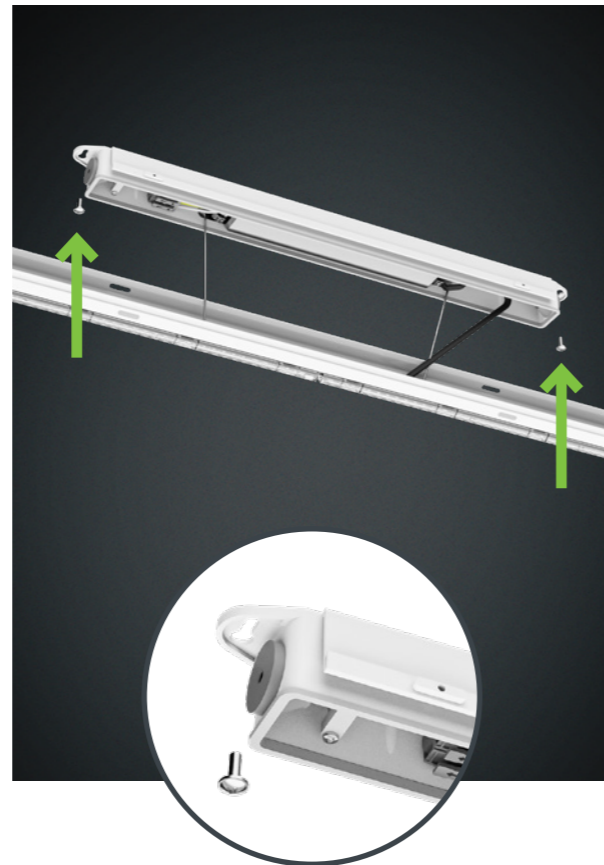

01

Attach the mounting box to the ceiling using two screws.



02

Feed power through the terminal block

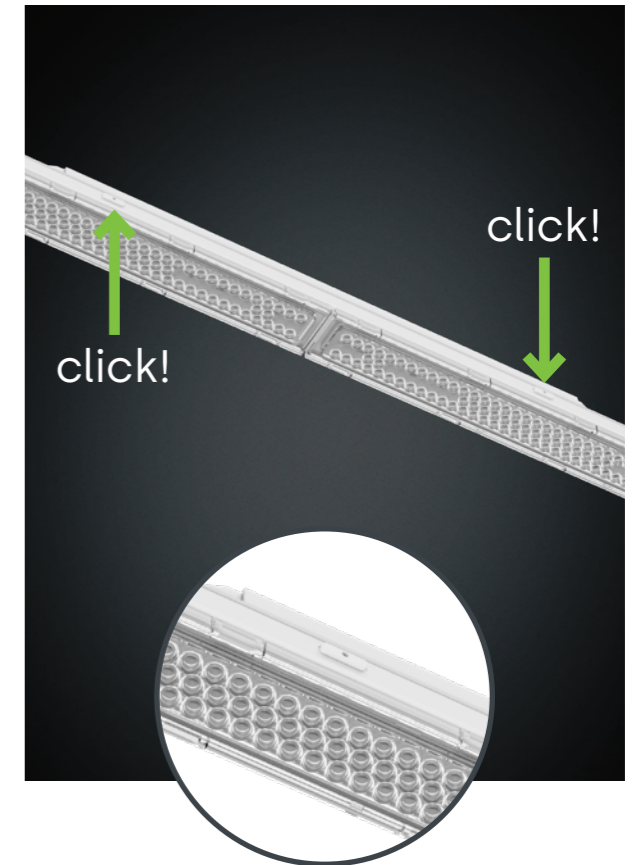

03

Click the module into position

Advanced **optics**



Equipped with cutting-edge optics, the Tytan Steel LED PRO luminaire ensures precise lighting performance in various conditions. Available in ten different light distribution options, it enables users to tailor the lighting to their specific requirements. The range also includes versions with UGR distribution, which minimise glare, providing comfortable working conditions in demanding environments, such as offices or industrial spaces.

SW
MW
VW
SN
VN
CN
DAN
SA
105°
120°

Metal **body**

The Tytan Steel LED luminaire is made of steel, ensuring exceptional durability, and thanks to the U-shaped profile construction, it is not heavier than a plastic housing. It makes the luminaire appear light and yet solid, which facilitates installation and does not overload the supporting structure.



- + More resistant to mechanical damage and cracking.
- + Better thermal performance – steel is better at dissipating heat.
- + Greater fire safety.
- + Resistance to degradation from UV exposure or elevated temperatures. Longer lifespan of the housing itself.

Ultimate **tightness**

With an IP65 rating, the Tytan Steel LED luminaire is entirely resistant to dust and protected against water jets.

It has been developed with a cutting-edge design in mind. The top plane of the luminaire has a specially designed shape that enables water to drain freely if it should collect there.

High tightness ensures a long lifespan and reliable operation of the luminaire, even in the most demanding environments.



IP **65**



Range of versions

The Titan Steel LED luminaire is available in many versions, which can be adapted to various needs and applications.

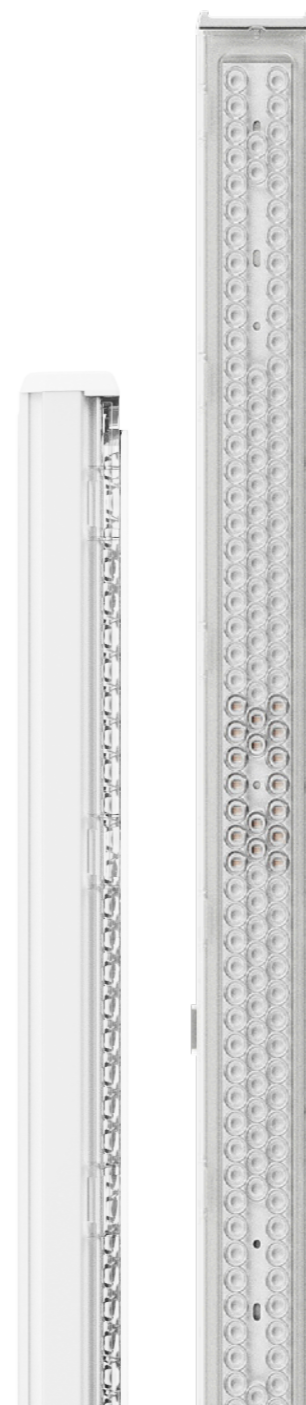

- 01 **On/off version**
Basic version of the luminaire
- 02 **LS2 versions**
Version enabling through-wiring of luminaires in a line
- 03 **Version with a motion sensor**
Activates light upon motion detection
- 04 **DALI version**
Provides advanced lighting control
- 05 **Clue version**
It offers sophisticated lighting management, accessible from the app
- 06 **Version with an emergency module**
It guarantees luminaire operation in the event of a power outage
- 07 **PRO version**
Advanced optics and luminous efficiency up to 192 lm/W

Illumination of a production hall

Surface area: 10,000 m²,
Luminaire mounting height: 6 m.

Due to the functional purpose of the space, a lighting level of 300 lx on the work surface was required. Due to the 16-hour mode of lamp usage duration, energy efficiency was the most important criterion for their selection. Another condition for choosing the product was its reliability, because each downtime in the production process generates unnecessary costs.

So far, the facility has been fitted with 2x58W EVG fluorescent luminaires. Considering investor's key requirements, we proposed replacing traditional luminaires with **Tytan Steel LED PRO 36W 4000K 5950lm.**

69.0%
annual energy savings

7 months
return on investment

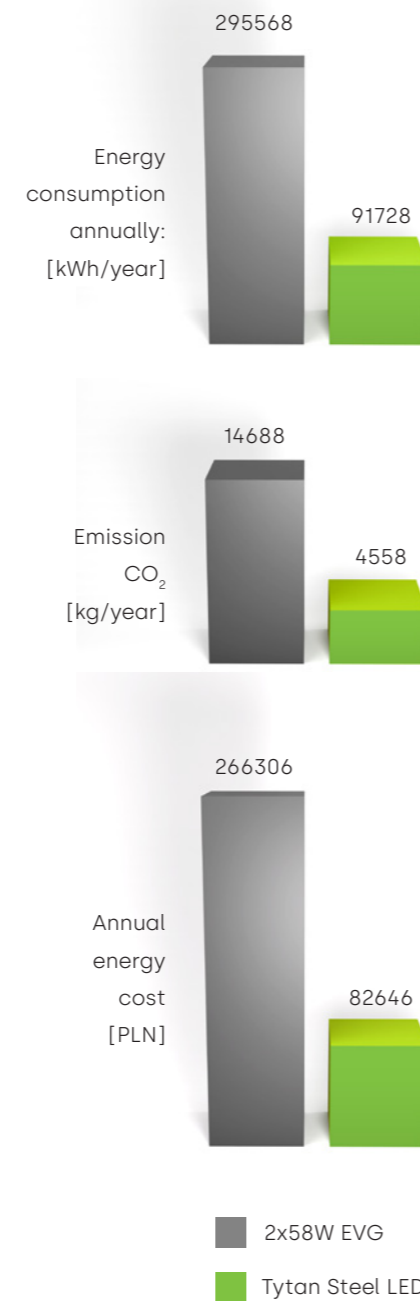

Application



01 Industrial halls and warehouses

The Tytan Steel LED luminaire is perfectly suited for halls and warehouses due to its high luminous efficiency, dust and water resistance (IP65), and ease of installation in hard-to-reach areas.

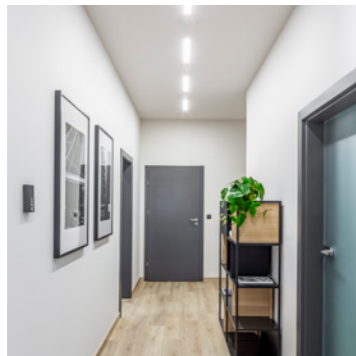

02 Corridors, garages

Thanks to its compact design, resistance to dust and water (IP65), and high luminous efficiency, the Tytan Steel LED luminaire is ideal for use in corridors and garages.

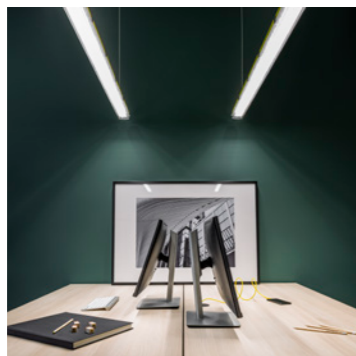

03 Office

The Tytan Steel LED luminaire is a great choice for office environments because of its UGR optics, which minimise glare and enhance working comfort. Its modern design and high luminous efficiency ensure aesthetic and functional lighting, while low operating costs and long lifespan contribute to savings and reliability.

Design

The Tytan Steel LED luminaire stands out with its intriguing and modern design that sets it apart from classic luminaires. It features a low profile and slim shape, giving it an elegant and modern look. It is available in two classic colours: white and black, and in two lengths: 0.6 m and 1.2 m.

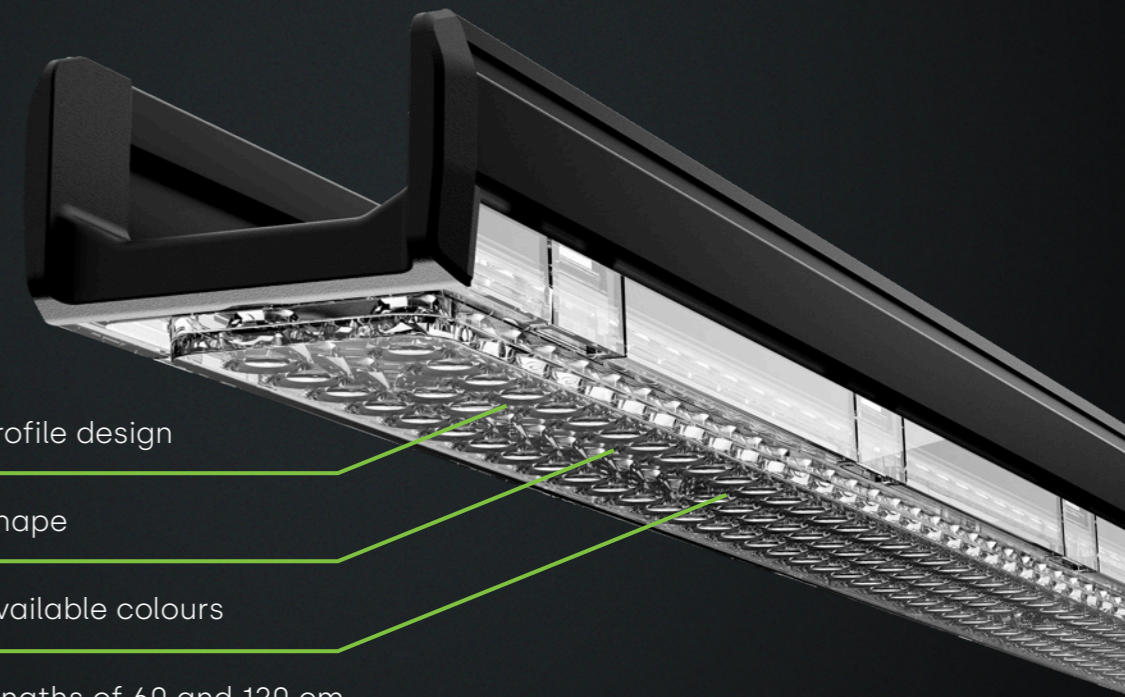

low-profile design

slim shape

two available colours

two lengths of 60 and 120 cm

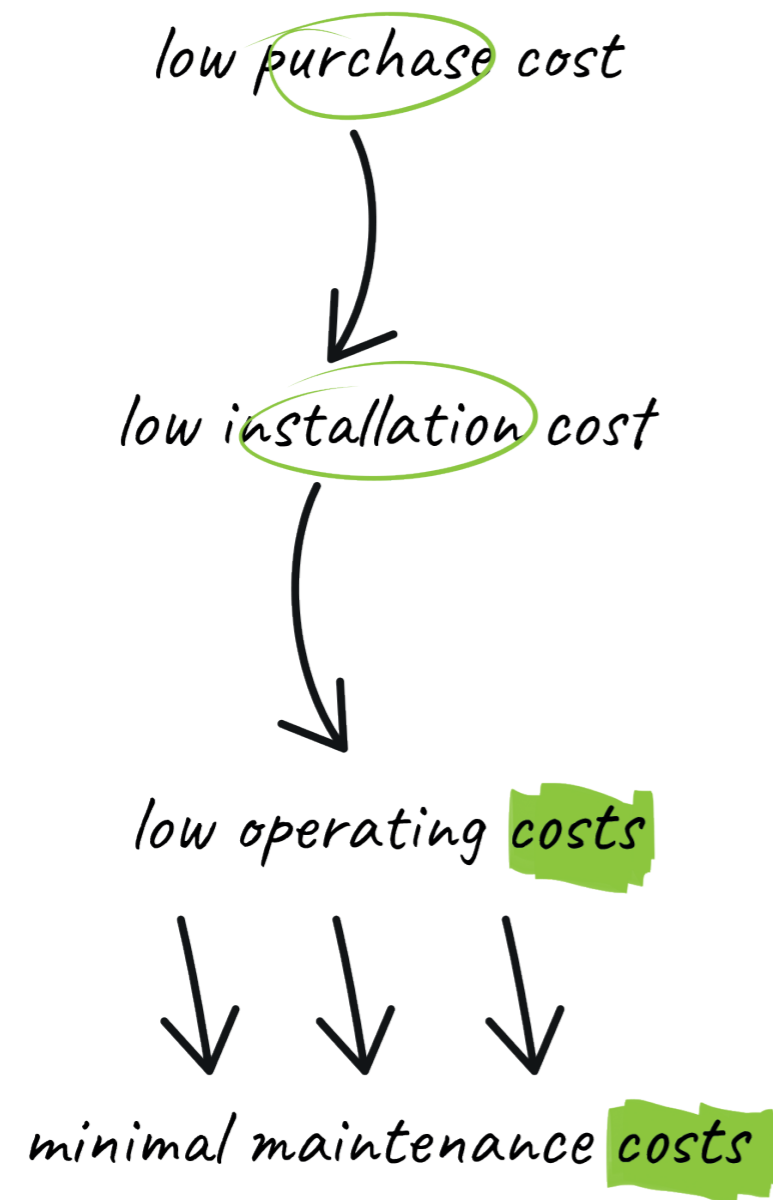

The Tytan Steel LED luminaire delivers comprehensive savings from purchase to operation. Its low purchase cost is just the start of further benefits. Thanks to quick and easy installation, the installation costs are minimal. The luminaire is characterised by low operating costs and long lifespan, which translates into lower energy bills and infrequent maintenance.

High-quality craftsmanship, branded components, and precise "made in Poland" manufacturing ensure reliability and durability, which further reduce the costs of maintenance.

Economy at every step

100%

Made in Poland

We are a lighting manufacturer with 35 years of presence on the market, which is why we know everything about luminaires and lighting systems: we design, comprehensively test and manufacture them. We combine practice with modernity.

We have technologically advanced manufacturing facilities at our command, which guarantees a high level of flexibility and operational efficiency. We produce millions of luminaires annually, and each product leaving the Lena Lighting production line strengthens our position of the leader in the market of luminaires in the country and in the world – every day.

When designing new luminaires, we take advantage of the latest achievements in technology. For years, we have cooperated with leading international manufacturers of electrotechnical components, who, in addition to providing us with their solutions, also implement individual projects of our Engineers at the Research and Development Department of Lena Lighting S.A., allowing for a significant reduction in energy consumption, while improving the quality of lighting. We are constantly enhancing our know-how using the latest global solutions in LED technology and lighting control.

35+
years
of experience





Lena Lighting

Lena Lighting S.A.
ul. Kórnicka 52, 63-000 Środa Wielkopolska
tel. +48 (61) 28 60 300, e-mail: kontakt@lenalighting.pl

www.lenalighting.com